



2 0 1 1 - 2 0 1 2

800.869.7460



Who and What We Are.

We are an industry-respected German manufacturer of precision measuring tools.

Our levels and measuring instruments are the preferred choice for professional craftsman throughout the world because precision measuring tools eliminate rework and callbacks. Precision measuring tools allow for faster, easier and more profitable work.

All of our tools are factory tested and durable; built to handle real world job site conditions while providing craftsmen with the dependability and consistent accuracy they expect and deserve.

Dr. Wolfgang Schaefer

President and CEO



Commitment to Accuracy.

Stabila Tolerances

All accuracy tolerances stated by Stabila are absolute values. Stabila products will never perform below their stated accuracy.

WARRANTY

SPIRIT LEVELS: STABILA levels will maintain their stated accuracy for life. The vials on all STABILA levels will not fog, leak or become inaccurate. If they do, you will be given a new level. **Bent frames void warranty.**

LASERS and TECH LEVELS: We will repair, without charge, any defects due to faulty materials or workmanship for 2 years from date of purchase. Proof of purchase required. 48 Hours Service Turnaround Time.

ACCESSORIES: Tape Measures, Tripods, Cases, Grade Rods, Etc. 30 day warranty against manufacturer defects from the date of purchase. Proof of purchase required. For a detailed explanation of our warranty refer to the products specific owners manual.

TECH

IP 65
DUST & WATERPROOF

Vial+Digital

Fast+Accurate Calibration System

NEW



TYPE 196-2

CAT. #		LENGTH
36514	TECH Level with Case	14"
36524	TECH Level with Case	24"
36548	TECH Level with Case	48"

196-2 - 1 horizontal vial, 2 vertical vials
 14": no handgrip - 24": 1 handgrip
 48": 2 handgrips

TYPE 96M-2 MAGNETIC

CAT. #		LENGTH
36520	Magnetic TECH Level with Case	24"
36540	Magnetic TECH Level with Case	48"

96M-2 - 1 horizontal vial, 2 vertical vials
 24": no handgrips - 48": 2 handgrips

Carrying Cases & Replacement Endcaps: Page 28



- On/Off
- Mode: Select: degrees, percent, rise and run in both inch and metric. Displays decimal or fractional readings.
- Cal: Calibration Button.
- Hold: Temporarily save the current measurement on the screen.
- Ref: Set any angle/slope as "0.00"
- Illuminates displays.
- Key-Lock: Select a mode and lock it in. Block and lockout the other modes.
- Sound Control: The flat tone indicates "Level". Position materials using sound when displays and the vial are out of view.



* Vial + Digital Calibration System



Simple Water & Brush Clean-up



* Two Displays Light Up



* Correct read even upside down



"Rare Earth" Magnets

2 AA Batteries included.
 Measuring accuracy of the vials: In normal position 0.029° = 0.5 mm/m
 Overhead measurement 0.029° = 0.5 mm/m - 0.029 = 1/32" over 72"
 Electronic accuracy: at 0° and 90° = ± 0.05°, from 1° to 89° = ± 0.2°

WARRANTY: We will repair, without charge, and defects due to faulty materials or workmanship for 2 years from date of purchase. Proof of purchase required. 48 Hours Service Turnaround Time.

Vials Light Up



Two Removable Light Paks

TYPE 196LED

CAT. #	DESCRIPTION
39324	24" Lights Levels with 2 Light Paks
39340	48" Lights Levels with 2 Light Paks
39348	24"/48" Lights Levels with 4 Light Paks and 59" Pro-Tector™ Case
20090	Replacement Light Paks (2)



Battery Type	Run Time	Bulb Type	Switch Type	IP Rating
CR2016 - requires 2 per Light Pack	Continuous: 5 hours Approx.: 600 uses	LED	Magnetic	IP54 dust & water



**Switch
On/Off**



LEVEL



PLUMB

**Easy
Reading**



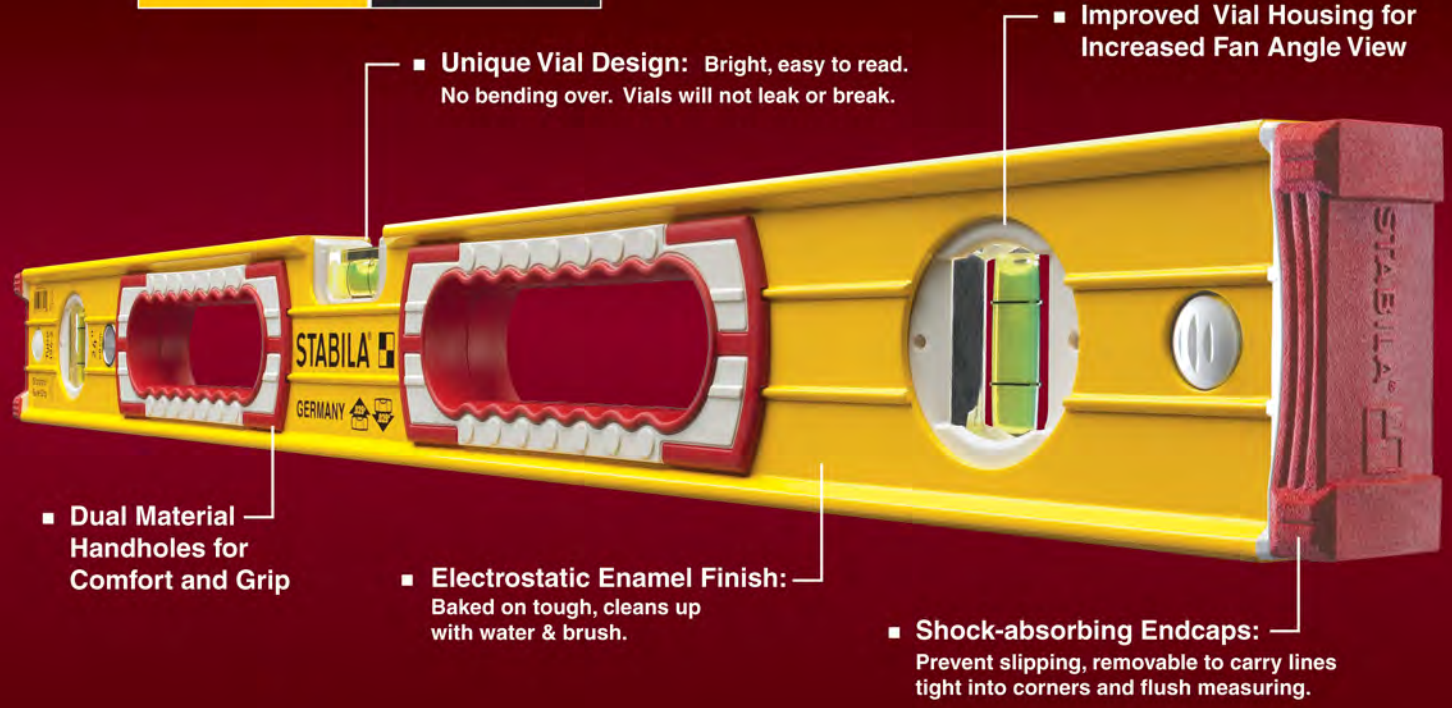

■ **Unique Vial Design:** Bright, easy to read. No bending over. Vials will not leak or break.

■ **Improved Vial Housing for Increased Fan Angle View**

■ **Dual Material Handholes for Comfort and Grip**

■ **Electrostatic Enamel Finish:** Baked on tough, cleans up with water & brush.

■ **Shock-absorbing Endcaps:** Prevent slipping, removable to carry lines tight into corners and flush measuring.



Readable in every direction with no change in accuracy tolerance.



Try to pull our magnetic levels off steel without twisting your wrist.

TYPE 196

CAT. #	LENGTH
37416	16" 1 Plumb Vial, 1 Handhole
37424	24" Handholes
37432	32" Handholes
37436	36" Handholes
37448	48" Handholes
* 37459	59" Handholes
37472	72" Handholes
37478	78" Handholes
37524	59" plus 24" Handholes
37532 Jamber Set®	78" plus 32" Handholes
37496 (Type 96)	96" without Handholes

TYPE 96M MAGNETIC

CAT. #	LENGTH
38616	16" without Handholes
38624	24" without Handholes
38632	32" without Handholes
38636	36" without Handholes
38648	48" Handholes
* 38659	59" without Handholes
38672	72" Handholes
38678	78" Handholes
38524	59" plus 24" without Handholes
38532 Magnetic Jamber Set®	78" plus 32"
* 38696	96" without Handholes

Carrying Cases & Replacement Endcaps: Page 28



EPOXY-LOCKED VIALS



GUARANTEED FOR LIFE

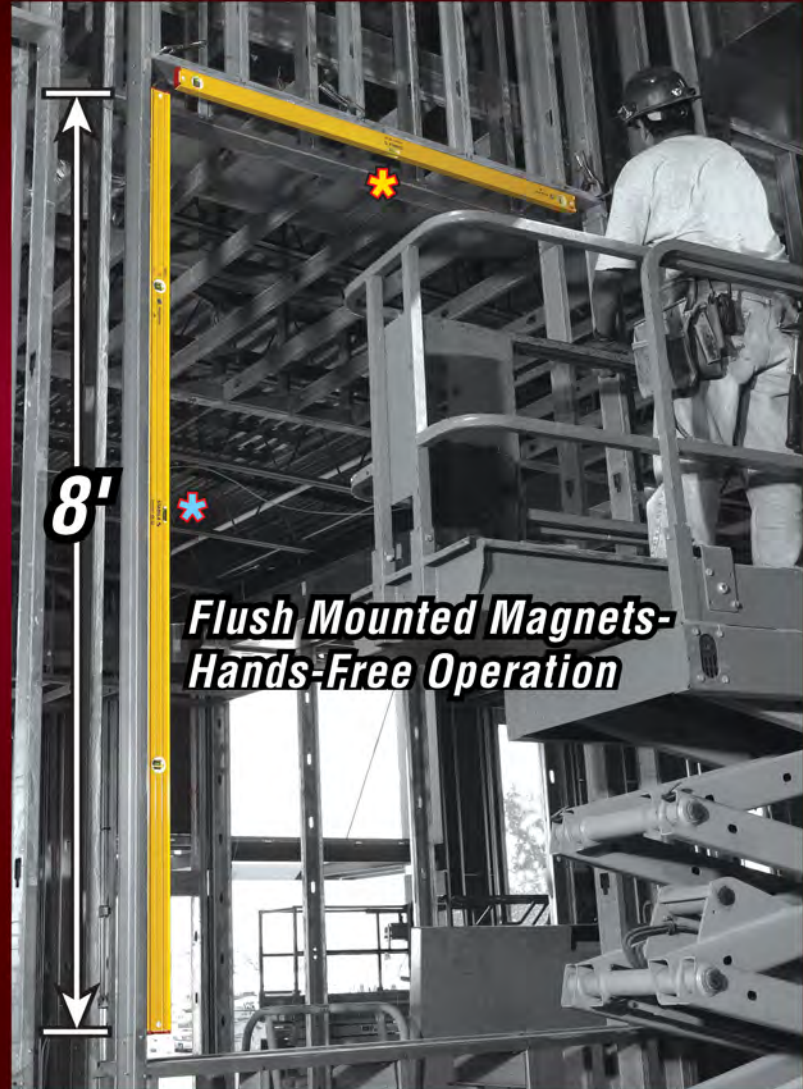

Flush Mounted Magnets- Hands-Free Operation



* 59" The New Standard



Magnetic Jamber Set

* Magnets Grab Hinge Leaves

- Windows
- Setting pairs of 2/6, 2/8 and 3/0 doors
- Flattening studs
- Closet shelf layout
- Fits behind pick-up truck seat and in gang boxes
- It's as long as your reach - scribe in one pass

Levels 59" and longer have a bridge over the horizontal vial for increased frame strength and uninterrupted scribing. STABILA levels are manufactured to metric dimensions. All stated level lengths in this catalog are "soft" conversions.

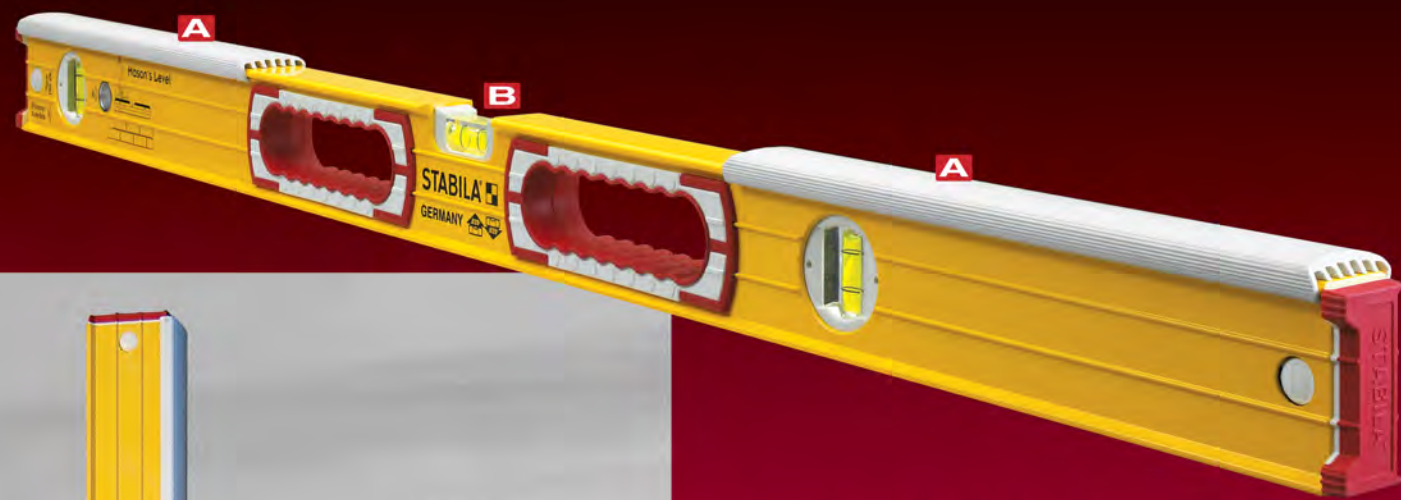

A *Designed to be HIT with a Trowel.*
Patented "Dead Blow Shield" protects the frame and transfers the energy from the trowel hit to the work surface.

B *Top mounted horizontal vial for visibility, minimizes bending over.*

C *Vertical vial right where you want it.*

- Frame will not warp or twist
- Water and brush clean-up
- Certified accuracy in reading positions: 1/32" over 72"
- Level accuracy guaranteed for life; vials will never fog, leak or require adjustment

TYPE 196-2K

CAT. #	LENGTH
36416	16" without Handholes
36424	24" without Handholes
36436	36" Handholes
36448	48" Handholes
48196	48 COMPLETE Mason's Set 48", 24", Torpedo & Case

Carrying Cases & Replacement Endcaps: Page 28



STABILA levels are manufactured to metric dimensions.
All stated level lengths in this catalog are "soft" conversions.

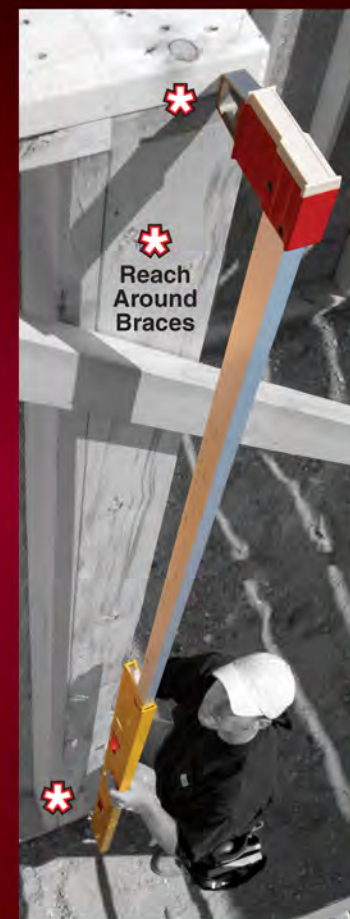

TYPE 106T

CAT. #	LENGTH
35610	6' - 10'
35712	7' - 12'
33000	Maintenance Kit
33100	Replacement 1 5/8" Stand-Offs



Simply twist-on to add Stand-Offs

- Strong Re-Enforced Frame
- Certified accuracy in normal positions: 1/32" over 72"
- Frame side opposite stand-offs is a level measuring surface & straight edge
- Scale on both sides of extension for FAST Set-ups: 8'-1", 9'-1", 10'-1" etc.
- Plumb vial always at eye level



TYPE 106TM MAGNETIC

CAT. #	LENGTH
34610	6' - 10' Magnetic
34712	7' - 12' Magnetic
33000	Maintenance Kit

THE MEASURING STICK

Rehab • Remodel • Restore

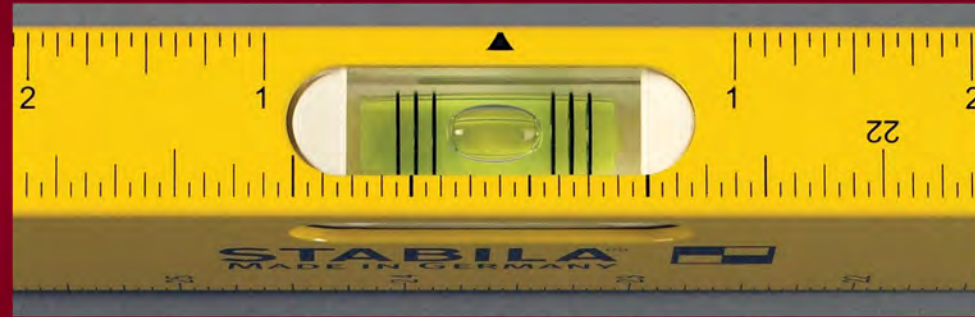

- 3 Layout Scales • Double Bridge Frame
- Slope Indication Rings



Removable Endcaps to carry lines tight into corners

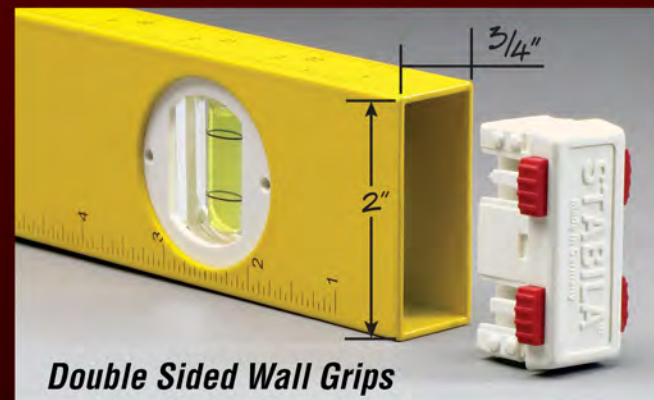

Double Sided Wall Grips

TYPE 80A-2

CAT. #	LENGTH
29148	48" The Measuring Stick (120cm)



0"



Easy to Grip • Easy to Read • Easy to Clean

- STABILA's general construction level. Perfect for tile installers and all jobsite applications.
- Easy, crystal clear top and side reading horizontal vial
- Rugged, takes rough handling
- Certified accuracy in normal reading positions: 1/32" over 72"
- Level accuracy guaranteed for life; vials will never fog, leak or require adjustment

TYPE 80A-2

CAT. #	LENGTH
29024	24"
29036	36"
29048	48"
29072	72"
29078	78" NEW! 2 1/2" vs. 2"
29096	96" frame height for 78" & 96"
29824	ProSet 48", 24", & Torpedo

TYPE 80A-2M MAGNETIC

CAT. #	LENGTH
29224	24" Magnetic
29248	48" Magnetic
29272	72" Magnetic
29924	Magnetic ProSet 48", 24", & Torpedo



TYPE 80A-2E DIGITAL

CAT. #	LENGTH
29624	24" 1 level vial plus electronics
29648	48" 1 level vial plus electronics



NEW

POCKET LEVELS

CAT. #	SIZE
11990 Magnetic	1 5/8" x 2 5/8"
11985 Non-Magnetic (not shown)	1 5/8" x 2 5/8"
11901 PRO Magnetic with Holster	1 5/8" x 2 5/8"

- STABILA's PRO quality in a small format
- A Must Tool For Anyone
- Large, easy read Vial
- Handy - Light - Precise
- Magnetic bar for horizontal and vertical hold (11995)



DIE-CAST TORPEDO LEVELS

CAT. #	LENGTH
25010 2 Vial, non Magnetic (not shown)	10"
25100 2 Vial, Magnetic (not shown)	10"
25245 3 Vial, 45° w. "V-Groove", Magnetic	10"
25360 3 Vial, 360° w. "V-Groove", Magnetic	10"
30001 Leather Holster (not shown)	

- Big, bright, easy to read vials
- **Magnetic - Try to pull them off steel without twisting your wrist.**
- Heavy-duty, die-cast frame
- Certified accuracy in normal reading positions: 1/32" over 72"
- Level accuracy guaranteed for life; vials will never fog, leak or require adjustment
- 1/8" and 1/4" per ft. Grade Rings on 25245 and 25360



EPOXY-LOCKED VIALS



GUARANTEED FOR LIFE

LASER MEASURES

Measurement Taken
@ This Laser Point
Within 1/16"

Our Most Advanced System

LD500 Laser Measure

- Range: up to 650 feet
- Camera Target Locator with 4X Zoom
- ± 1/16" accuracy throughout range
- Stores last 20 measurements
- Dust and water protected - IP54
- Built in Inclinometer - measures degrees, percentage of grade and slope
- Integrated Calculator - readings can be added to multiplied, subtracted from, etc.
- 2 Year Warranty & 48 hr. service turnaround

TYPE LD500

Cat. #	Range	Accuracy	Battery Life	Batteries
06500	650'	1/16" over range	Up to 5,000 measurements	2 x AAA

Built-In Video Camera!



06500



LD400 Laser Measure

- Range: up to 200'
- Length, Area, Volume, Continuous Measure, Square Footage, Pythagorean; Add or Subtract
- 1/16" accuracy throughout range
- Stores last 10 measurements
- Bright back-lit screen
- Carrying Case and Belt pouch

- METAL HOOK**
- Hooks Edge
 - Points for inside corner/diagonal measurements



TYPE LD400

Cat. #	Range	Accuracy	Battery Life	Batteries
06400	200'	1/16" over range	Up to 5,000 measurements	2 x AAA



LASER WARRANTY
2 Years:
 Repair without charge faulty materials or workmanship. (Proof of purchase required)
48 Hours:
 Service Turnaround Time



LD300 Laser Measure

- Range: up to 100 ft.
- Length, Volume, Square Footage, Continuous Measure, Pythagorean
- 1/16" accuracy throughout range
- Bright back-lit screen
- Carrying Case

TYPE LD300

Cat. #	Range	Accuracy	Battery Life	Batteries
06300	100'	1/16" over range	Up to 3,000 measurements	2 x AAA



LaserBob™ Layout Kit

03149

- 4 Beams:**
- Plumb-up
 - Plumb-down
 - Level
 - Square



LASER WARRANTY
2 Years:
 Repair without charge faulty materials or workmanship. (Proof of purchase required)
48 Hours:
 Service Turnaround Time



TYPE LA-4P Includes: LA-4P Laser and Carrying Case

Cat. #	Working Range	Self Leveling Range: (horizontal)	LEVELING ACCURACY				Batteries Included	Battery Life
			Up Beam	Down Beam	Level Beam	Square Beam		
03149	65 - 100' 20 - 30m	± 4°	± 1/4" @ 70' ± 6mm / 21m	± 1/4" @ 2.5' ± 1mm / 0.5m	± 1/4" @ 100' ± 6mm / 30m	± 1/4" @ 100' ± 6mm / 30m	4 x Alkaline Size AA	Approx. 40 Hours



ProLiner™ LASER

03269 - Indoor Laser
03275 - Outdoor Kit



Line hits the floor within an inch



Rare-Earth, "V-Groove" Magnet



#03275
Outdoor/Indoor Kit

- FAST - Leveling Lines
- Pendulum Lock
- Lens Cover
- Rubber Housing
- Integrated Magnetic Mount
- 1/4" - 20 and 5/8" - 11 tripod mounts
- 4 Modes: - Horizontal
- Vertical
- Cross-Line
- Fixed Cross-Line for Angles
- Pulse Technology - use with Receiver (03269 - Receiver not included)



Integrated Magnetic Wall Mount



Lens Cover

03275 ProLiner Laser Outdoor/Indoor Kit

Includes (as shown): LAX200 Laser, Pulse Receiver with Bracket, Metal Wall Plate, Magnetic Target Plate, Tripod Adaptor, Carrying Pouch, Batteries, Manual, & Hard Shell Case.

03269 ProLiner Indoor Laser

Includes: LAX200 Laser, Metal Wall Plate, Tripod Adaptor, Carrying Pouch, Batteries and Manual.
(Pulse Receiver with Bracket, Target Plate, and Hard Case are not included)

LASER WARRANTY
2 Years:
Repair without charge faulty materials or workmanship. (Proof of purchase required)
48 Hours:
Service Turnaround Time



TYPE LAX200

Catalog #	Self-Leveling Range	Working Range	Accuracy Rating	Batteries	Battery Life
03269 & 03275	± 4.5°	Indoor - Visual: 30' (10m) Outdoor - with Receiver: 300' (100m)	Horizontal Line: ± 5/32" @ 50' Vertical Line: ± 5/32" @ 50' Line Inclination: ± 1/8" @ 50'	3 x AA 1.5V	Approximate: 30 Hours



05155

- **Fast**
- **Easy**
- **Dependable**

LASER WARRANTY
2 Years:
Repair without charge faulty materials or workmanship.
(Proof of purchase required)
48 Hours:
Service Turnaround Time



Battery Drawer: Easy replacement directly on the tripod



Quickly change from horizontal to vertical position



NEW
Easy to use Receiver Slide

- Range: 600 ft. with Receiver (180m)
- Rotation horizontal and vertical, 3 stage scan, plumb line, 90° angle
- Dust and water rating (IP 54)
- No waiting: FAST self-leveling with pendulum technology
- Protected by metal roll cage and shock absorbing rubber
- Pendulum protected during transport
- Accuracy horizontal: ± 1/4" over 100' (± 0.2mm/m)
- Accuracy vertical: ± 5/16" over 100' (± 0.3mm/m)
- Long operating battery life: approximate 80 hours
- Easy Control Pad

05155 ResCon Laser System
Includes: LAPR150 Rotating Laser, Receiver with Clamp, Fixed Head Tripod, Hi/Lo Elevation Rod, Target Plate, 2D 1.5V Batteries, Hard Shell Case

TYPE LAPR150

Catalog #	Self-Level Range	Dia. Receiver Range	Accuracy Horizontal	Accuracy Vertical	Tripod Mount	Battery Life
05155	5°	600' / 180m	± 1/4" @ 100' / ± 0.2mm/m	± 5/16" @ 100' / ± 0.3mm/m	5/8"-11	80 hours
07450 Receiver		08598 Fixed Head Tripod			07468 Hi/Lo Elevation Rod	

STABILA ...sets standards

05600 - Fully Loaded System

05610 - Laser Kit

*** The Remote Controls:**

- Variable Rotation Speeds
- Laser Dot left/right
- Scan/ Lines left or right
- Vertical left or right 5° steering
- Slope/Grade ± 5° in one direction

DE-TECH
Laser Receiver

OFF ROAD
LAYOUT SYSTEM

Square



Fully Automatic
INTERIOR / EXTERIOR LAYOUT SYSTEM
Self-Leveling, Rotating Laser



- Durable: Takes a 6' Drop
- Range: 1,150 ft. / 350m
- Variable Speed Rotation
- Accuracy: ± 1/8" over 100' ± 0.1 mm/m
- High Alert Shut Off Function
- Dust and Water Proof - IP65
- Rubber Exterior Over Metal Housing
- Shock Absorbing Interior



DE-TECH
Laser Receiver

Defined Elevation

07430 to the 1/16"

- Digital Read-Out Shows Exact Distance from Grade
- Arrows Show Direction to Grade
- 4" Reception Band
- Dust & Water Proof - IP 67
- Takes a 10' Drop

TESTED



✓ Tip-Over ✓ Dust ✓ Water



✓ Temp



05600 LAR250 OFF-ROAD Layout Laser System

Includes (as shown): LAR250 Rotating Laser, DE-TECH Receiver, Remote Control, Wall Mount, Magnetic Target Plate, 10" - 110" Elevator Tripod with Ground Kit, Hi/Lo Elevation Rod, Batteries 2xD, Manual & Hard Shell Case.

05610 LAR250 OFF-ROAD Layout Laser Kit

Includes: LAR250 Rotating Laser, DE-TECH Receiver, Remote Control, Wall Mount, Magnetic Target Plate, Batteries 2xD, Manual & Hard Shell Case. (Elevator Tripod with Ground Kit & Hi/Lo Elevation Rod not included)

LASER WARRANTY

2 Years:
Repair without charge faulty materials or workmanship. (Proof of purchase required)
48 Hours: Service Turnaround Time

TYPE LAR250

Catalog #	Self-Leveling Range	Diameter Receiver Range	Accuracy Rating	Batteries	Battery Life
05600 & 05610	± 5°	1,150' / 350m	± 1/8" @ 100' / ± 0.1mm/m	2 x D	up to 120 hours
07465 Wall Mount	07430 DE-TECH Receiver	08590 Elevator Tripod with Ground Kit	07468 Elevation Rod	07474 Target Plate	

Fully Automatic
EXTERIOR LASER SYSTEM
 Self-Leveling, Rotating Laser



- 05500** - Fully Loaded System
- 05510** - Laser Kit

- Durable: Takes a 6' Drop
- Range: 1,800 ft. / 550m
- Rotation Speed: 600 rpm
- One Button Operation
- Self Leveling Working Range: $\pm 5^\circ$
- Accuracy: $\pm 1/8"$ over 100' / ± 0.1 mm/m
- Temp. Resistant: 14° to 140°F (-10°C to +60°C)
- Rubber Exterior Over Metal Housing
- Shock Absorbing Interior
- Dust and Waterproof - IP65
- Battery Life: up to 120 hours

05500 LAR200 OFF-ROAD Laser System
 Includes: LAR200 Rotating Laser, DE-TECH Receiver with Clamp, Fixed Head Tripod, Hi/Lo Elevation Rod, Batteries 2xD, Manual & Hard Shell Case.

05510 LAR200 OFF-ROAD Laser Kit
 Includes: LAR200 Rotating Laser, DE-TECH Receiver with Clamp, Batteries 2xD, Manual & Hard Shell Case. (Fixed Head Tripod & Hi/Lo Elevation Rod not included)

• **Horizontal Only**
 • **1 Button Simple**

OFF ROAD

DE-TECH
 Laser Receiver

Defined Elevation to the 1/16"

07430

- Digital Read-Out Shows Exact Distance from Grade
- Arrows Show Direction to Grade
- 4" Reception Band
- Dust & Water Proof - IP 67
- Takes a 10' Drop



LASER WARRANTY

2 Years:
 Repair without charge faulty materials or workmanship. (Proof of purchase required)
48 Hours:
 Service Turnaround Time



TYPE LAR200

Catalog #	Self-Level Range	Dia. Receiver Range	Accuracy Rating	Rotation Speed	Tripod Connection	Battery Life
05500 & 05510	5°	1,800' / 550	$\pm 1/8"$ @ 100' / ± 0.1 mm/m	600 rpm	5/8"-11	120 hours
07430 DE-TECH Receiver		08598 Fixed Head Tripod		07468 Hi/Lo Elevation Rod		

HOLES IN A ROW *Simplified!*



- 08100**
1. Layout first 2 joists/studs. Drill first hole. Insert HL100, center and tighten down. Adjust the laser, using the dials, referencing the second layout. Dial in Level or Slope.
 2. Drill. All joists/studs are marked by the laser - ready to be drilled. Works with TJI's & Steel Studs

TYPE HL100 KIT

Cat. #	Accuracy Tolerance Upright	Range	Adjustment Range	Batteries Included	Battery Life
08100	± 1/16" over 10' ± 0.5 mm/m	75' 25m	± 3°	2xAA	48 hours

Includes: HL100 Laser, Large Locking Nut for holes from 3 1/4" to 4 3/4", Small Locking Nut for holes from 7/8" to 3", Adapter Plate for large diameter holes and steel studs (07500), Threaded Tube (07501), Manual and Batteries.



- Self-centers in Pipes or Holes: 1 1/2" to 4 1/4"
 1. Drop V2R in Pipe.
 2. Level
 3. Drill or Cut
 4. Fast, Easy by Yourself



08500
Includes: V2R Laser, Carrying Case and Belt Clip

TYPE V2R

Cat. #	Working Range	Plumb Up Accuracy	Batteries Included	Battery Life
08500	75'	± 1/16" @ 10' (± 0.5mm/m)	2xAA	40 hours



DE-TECH Laser Receiver

Defined Elevation to the 1/16"

- Digital Read-Out Shows Exact Distance from Grade
- Arrows Show Direction to Grade
- 4" Reception Band
- Dust & Water Proof - IP 67
- Takes a 10' Drop



Receivers

CAT. #	DESCRIPTION
07430	DE-TECH Receiver
07440	Receiver (05200 Laser)
07450	Receiver (05000 Laser)

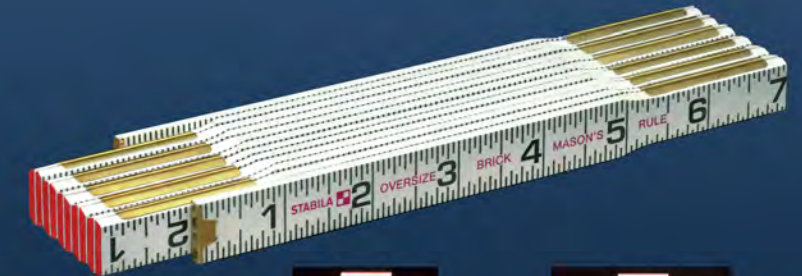

Hardened steel springs and steel joints



Fully sealed rivets with weather and abrasion protection

TYPE BM40

CAT. #	LENGTH
30316	16' Tape
30327	27' Tape
30333	33' Tape
30416	5 meter / 16' Tape
30427	8 meter / 27' Tape
30433	10 meter / 33' Tape

TYPE 600

CAT. #	DESCRIPTION
80001	Mason's (1/16ths - both edges - outside)
80005	Oversize Brick (1/16ths - both edges - outside)
80010	Modular Spacing (1/16ths - both edges - outside)
80015	Engineer's (1/16ths, 1/10ths, 1/100ths)
80101	Mason's 3 Pak
80105	Oversize Brick 3 Pak
80110	Modular Spacing 3 Pak
80115	Engineer's 3 Pak



2011 - 2012



**Elevator Tripod
with Ground Kit**

CAT. #	LENGTH
08590	46" - 112"

**Fixed Head
Tripod (not shown)**

CAT. #	LENGTH
07498	36" - 68"

Laser shown
for position only



**Replacement Parts
and Accessories**

CAT. #	DESCRIPTION
20015	80A-2 series level Endcaps (2)
20025	80A-2 Pro-Frame level Endcaps (2)
20020	87K series level Endcaps (2)
20030	87 and 187 level Endcaps (2)
20060	Plate Level series Endcaps (2)
20065	Plate Level 2 series Endcaps (2)
20070	196 / 96M series level Endcaps (2)
33000	Plate Level Maintenance Kit
33100	Plate Level 2 Stand-Offs (2)
37000	TECH Level Replacement Module
07465	Wall Mount Bracket with fine adjustment Fits: 05600, 05200 and 05000 Lasers
07470	Laser Enhancement Glasses
07474	Ceiling Target Plate
20090	Light Paks with Batteries (2 Pak)



33100

20065



30025

Carrying Cases

CAT. #	LENGTH
30001	Leather Holster for Torpedo (25010, 25100, 25245, 25360)
30010	48" Level
30015	48", 32", 24", 16" and Torpedo
30025	78", 59", 32", 24", 16" and Torpedo
30030	96" Level
30035	7' - 12' Plate Level Plus 59", 36"
30045	6' - 10' Plate Level Plus 59", 36"
30059	59", 32", 24", 16" and Torpedo



30001

7' (213cm)

+/- Hi/Lo Elevation Rod

- Yellow inch scale with 1/8" increments
- Red cm scale with mm increments

CAT. #	LENGTH
07468	52" - 7' (Imperial and 10ths)
07469	52" - 7' (Imperial and metric)

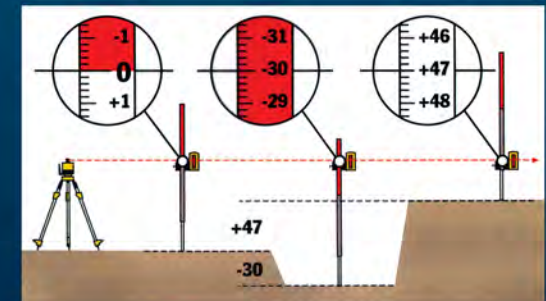

332 Industrial Dr., P.O. Box 402, South Elgin, IL 60177-0402

Phone: 800.869.7460 ■ In IL: 847.488.0050 ■ Fax: 847.488.0051 ■ Web: www.stabila.com ■ E-Mail: custservice@stabila.com